

Carré test  
2 cm x 2 cm



## Cigale

### la combishort, jupe-culotte & la robe

*Extension manches longues & encolure bord-côte*

3, 4, 5, 6, 7, 8, 9, 10, 11 et 12 ans

Marges de couture incluses de 0,8cm sauf indications contraires

#### Légende

↔ Droit fil

┌→ Coupe au pli

≡ Cran de montage

┌┐ Boutonnière

○ Bouton

	3 ans / 95 cm
	4 ans / 102 cm
	5 ans / 109 cm
	6 ans / 116 cm
	7 ans / 122 cm
	8 ans / 128 cm
	9 ans / 134 cm
	10 ans / 140 cm
	11 ans / 146 cm
	12 ans / 152 cm

Ce patron est strictement réservé à l'usage personnel. La reproduction et/ou la revente du patron ou de vêtements réalisés avec ce patron, sont strictement interdites.

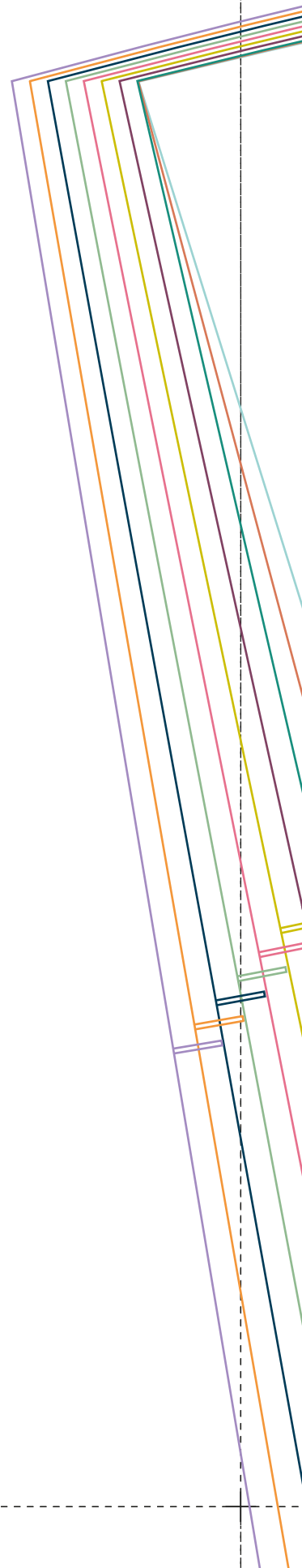
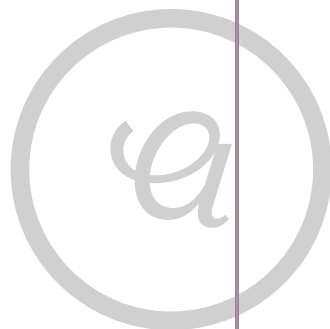

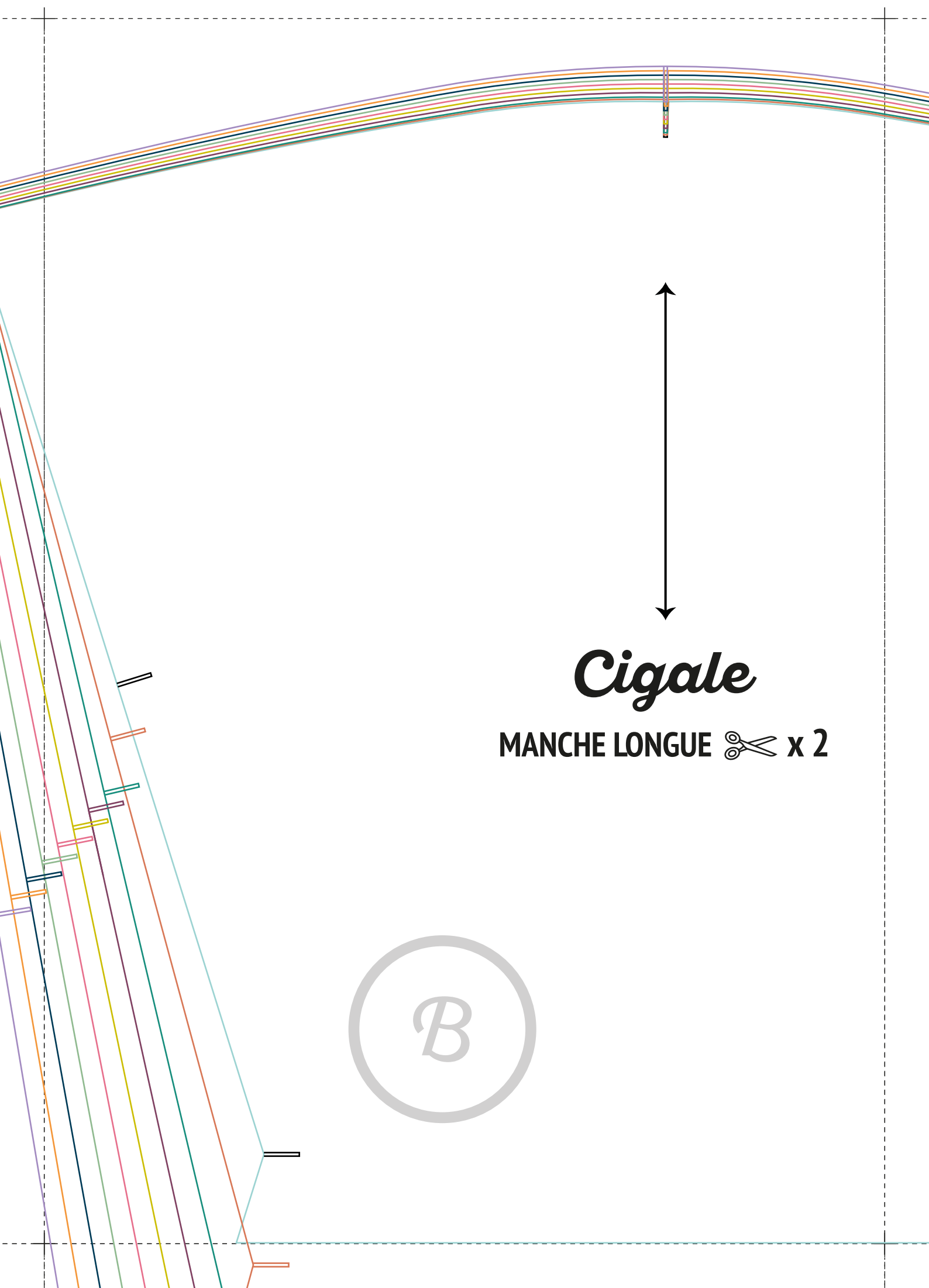

*Cigale*

MANCHE LONGUE ✂ x 2

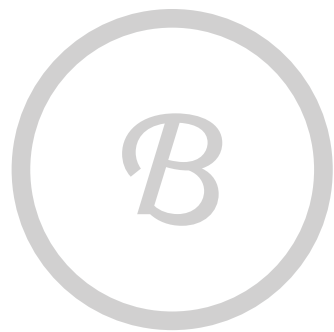

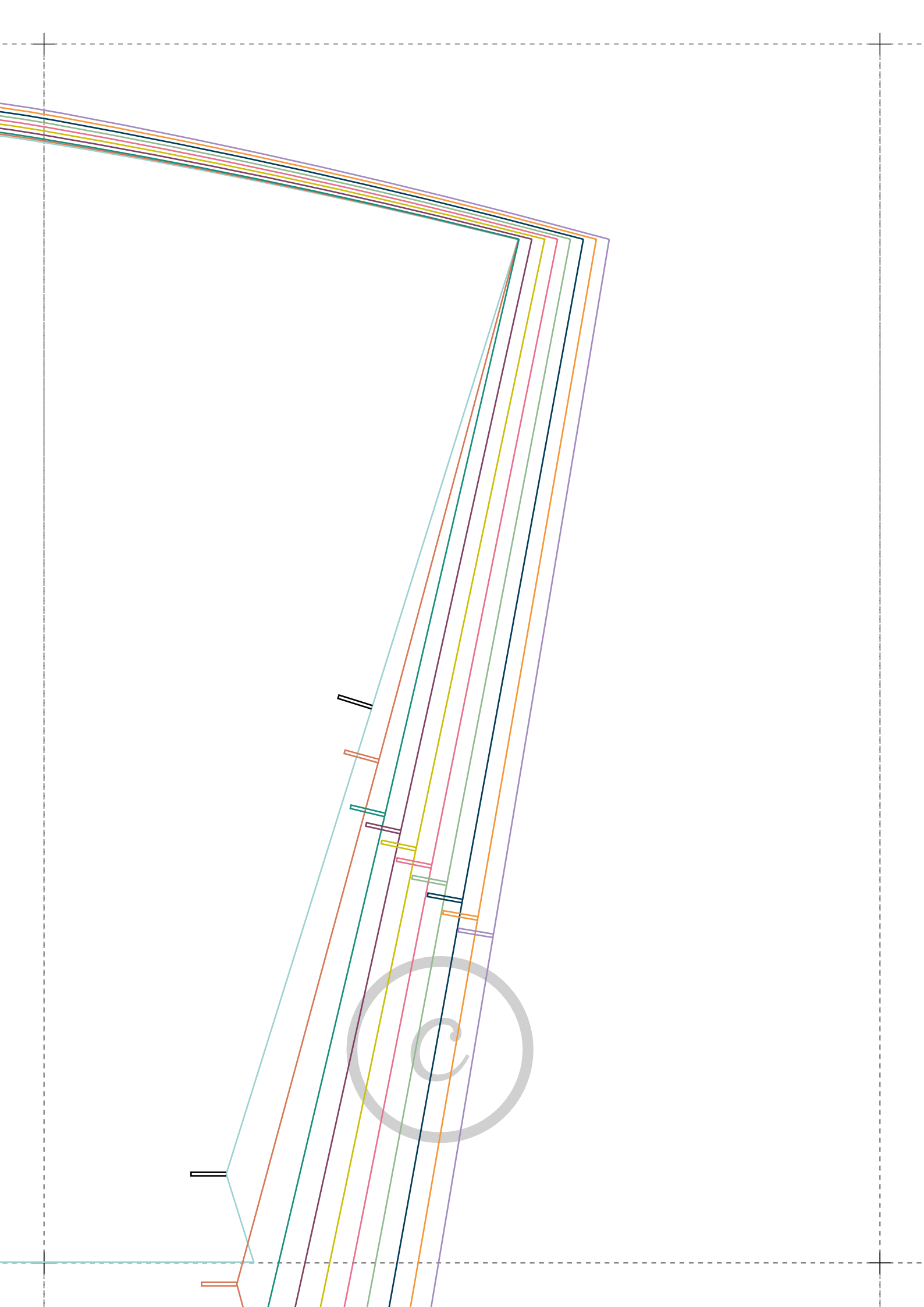

*Cigale*

BANDE ENCOLURE BORD-CÔTE ✂ x 1

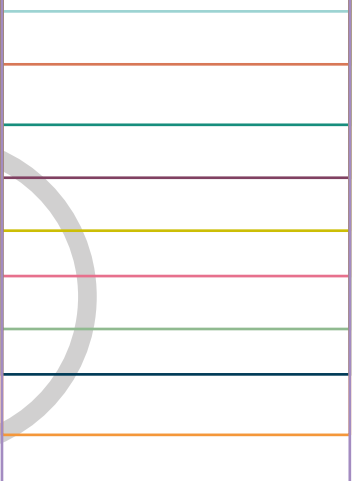
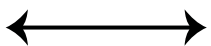

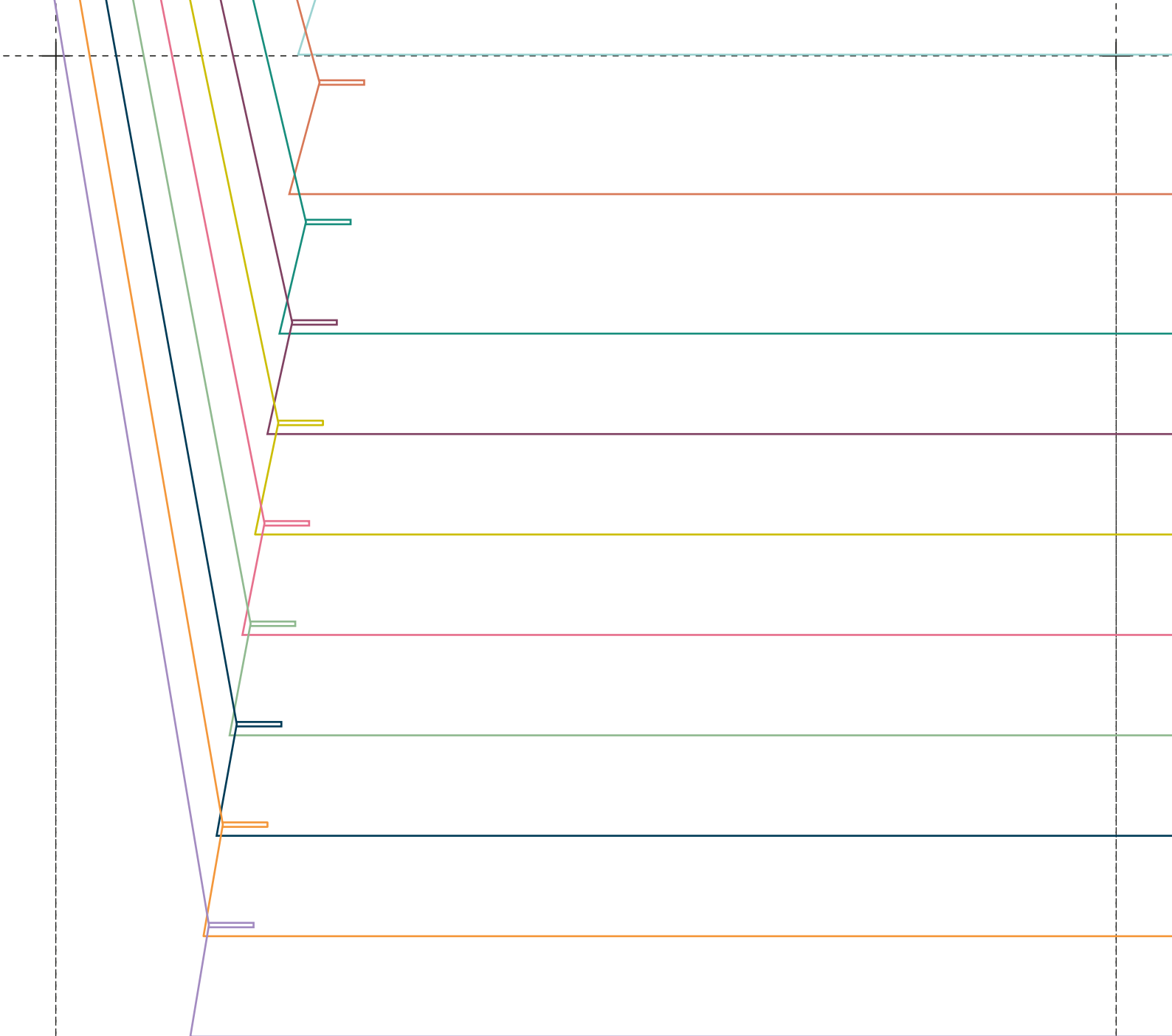

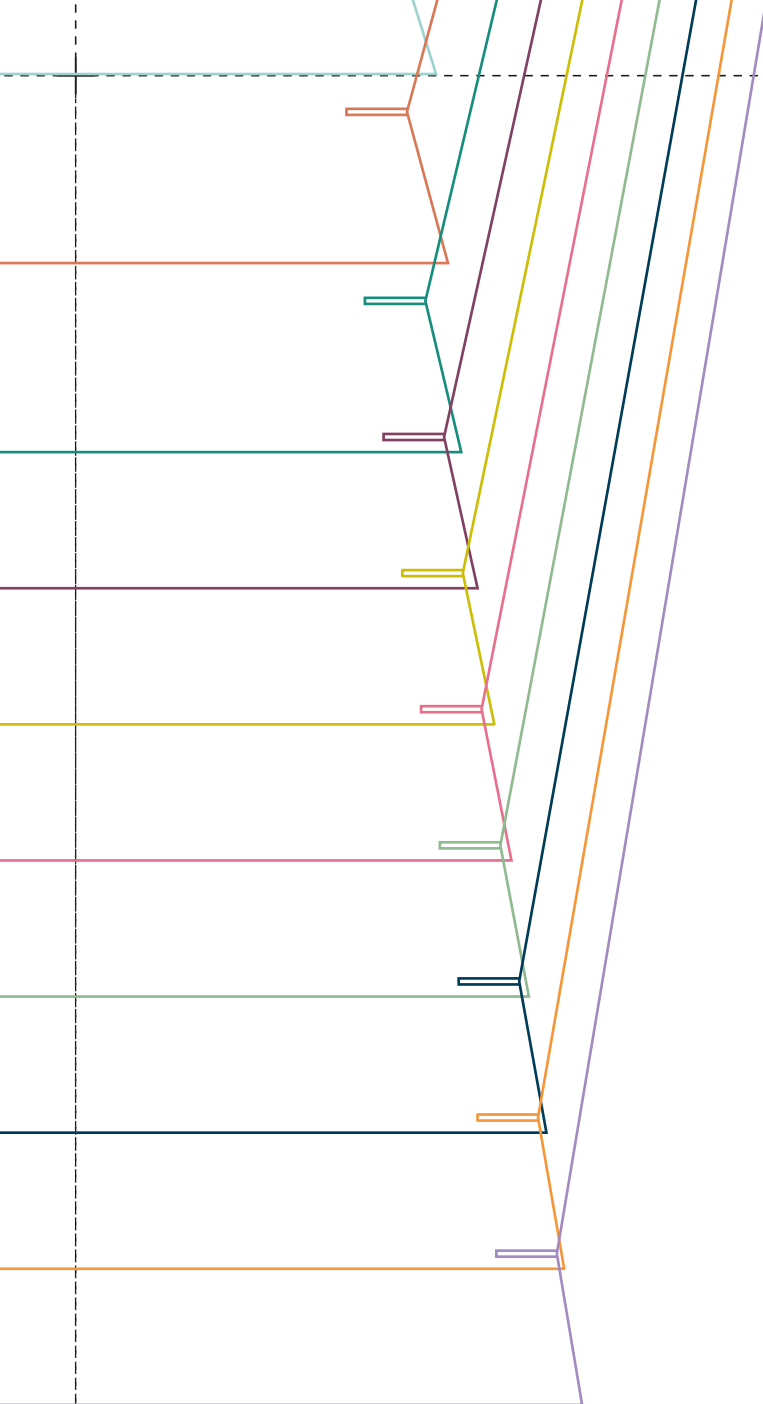

9